



CO-ORDINATED SCIENCES

0654/51

Paper 5 Practical Test

May/June 2019

CONFIDENTIAL INSTRUCTIONS



This document gives details of how to prepare for and administer the practical exam.

The information in this document and the identity of any materials supplied by Cambridge International are confidential and must NOT reach candidates either directly or indirectly.

The supervisor must complete the report at the end of this document and return it with the scripts.

If you have any queries regarding these confidential instructions, contact Cambridge International stating the centre number, the syllabus and component number and the nature of the query.

email info@cambridgeinternational.org
phone +44 1223 553554
fax +44 1223 553558

This document consists of **9** printed pages and **3** blank pages.

General information about practical exams

Centres must follow the guidance on science practical exams given in the *Cambridge Handbook*.

Safety

Supervisors must follow national and local regulations relating to safety and first aid.

Only those procedures described in the question paper should be attempted.

Supervisors must inform candidates that materials and apparatus used in the exam should be treated with caution. Suitable eye protection should be used where necessary.

The following hazard codes are used in these confidential instructions, where relevant:

C	corrosive	MH	moderate hazard
HH	health hazard	T	acutely toxic
F	flammable	O	oxidising
N	hazardous to the aquatic environment		

Hazard data sheets relating to substances used in this exam should be available from your chemical supplier.

Before the exam

- The packets containing the question papers must **not** be opened before the exam.
- It is assumed that standard school laboratory facilities, as indicated in the *Guide to Planning Practical Science*, will be available.
- Spare materials and apparatus for the tasks set must be available for candidates, if required.

During the exam

- It must be made clear to candidates at the start of the exam that they may request spare materials and apparatus for the tasks set.
- Where specified, the supervisor **must** perform the experiments and record the results as instructed. This must be done **out of sight** of the candidates, using the same materials and apparatus as the candidates.
- Any assistance provided to candidates must be recorded in the supervisor's report.
- If any materials or apparatus need to be replaced, for example, in the event of breakage or loss, this must be recorded in the supervisor's report.

After the exam

- The supervisor must complete a report for each practical session held and each laboratory used.
- Each packet of scripts returned to Cambridge International must contain the following items:
 - the scripts of the candidates specified on the bar code label provided
 - the supervisor's results relevant to these candidates
 - the supervisor's reports relevant to these candidates
 - seating plans for each practical session, referring to each candidate by candidate number
 - the attendance register.

Specific information for this practical exam

During the exam, the supervisor (NOT the invigilator) must do the experiments in Questions 1, 3, 4, 5 and 6 and record the results on a spare copy of the question paper, clearly labelled 'supervisor's results'.

For Question 1

Each candidate will require:

- (i) large test-tube approximately 150 × 25 mm with a horizontal line marked at 3 cm below the top
- (ii) test-tube approximately 125 × 15 mm with a horizontal line marked at 3 cm from the top
- (iii) means of supporting the test-tubes
- (iv) stopclock
- (v) thermometer capable of reading -10°C to 100°C graduated in 1°C intervals
- (vi) supply of hot water (see notes 1 and 2)
- (vii) supply of paper towels.

Notes

- 1 Each candidate will require approximately 100 cm^3 of hot water. The hot water should be supplied and maintained at a temperature of approximately 80°C or higher.
- 2 Candidates should be made aware of the dangers of burns or scalds when using very hot water.

Action at changeover

- Remove the thermometer from test-tube.
- Empty out used water from test-tubes.

For Question 2

No apparatus is required for this question.

For Question 3

Each candidate will require:

- (i) clamp, boss and stand
- (ii) pendulum bob attached to approximately 100 cm of thread
- (iii) split cork or similar to hold the thread in the clamp
- (iv) metre rule with a millimetre scale
- (v) stopwatch.

Notes

- 1 The pendulum must be set up for the candidates with a length of approximately 50 cm from the bottom of the split cork to the middle of the pendulum bob (see Fig. 3.1).

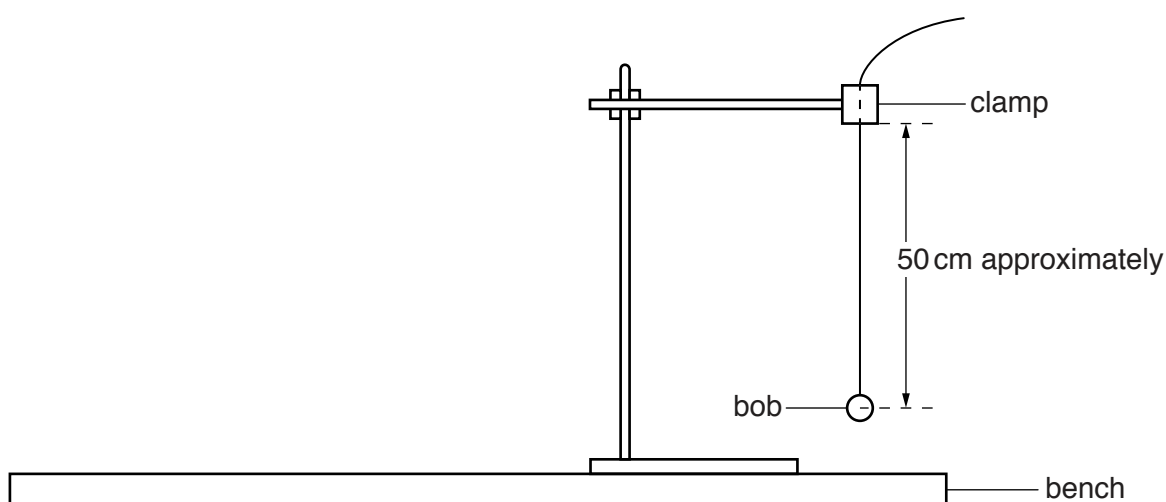
**Fig 3.1**

- 2 Candidates must be able to adjust the length of the pendulum easily up to a length of 80 cm. Retort stands of 80 cm or less in height may be used if the retort stand is reversed so that the pendulum hangs below the level of the bench. The base of the stand will need to be secured with a G-clamp and/or a heavy weight. Supervisors would need to warn candidates of the difference between the diagram in Fig. 3.1 and the set-up of their experiments.

Action at changeover

The pendulum is to be restored to the state described in note 1.

For Question 4

Each candidate will require:

- (i) half a stoned fruit (see note)
- (ii) 30 cm ruler graduated in mm.

Note

The fruit should be an apricot or plum (or similar sized fruit), with the stone removed and cut in half as shown below:



For Question 5

Each candidate will require:

- (i) approximately 10 cm³ 0.5 mol dm⁻³ sodium carbonate solution labelled **aqueous sodium carbonate**
- (ii) approximately 10 cm³ 0.5 mol dm⁻³ sodium sulfate solution labelled **aqueous sodium sulfate**
- [MH] (iii) approximately 30 cm³ 0.5 mol dm⁻³ ammonium sulfate solution labelled **H**
- [MH] (iv) approximately 20 cm³ 0.5 mol dm⁻³ nitric acid labelled **nitric acid**
- (v) approximately 20 cm³ 0.1 mol dm⁻³ barium nitrate solution labelled **barium nitrate**
- [MH] (vi) approximately 10 cm³ 0.4 mol dm⁻³ sodium hydroxide solution labelled **sodium hydroxide**
- (vii) approximately 10 cm³ 0.4 mol dm⁻³ ammonia solution labelled **ammonia solution**
- [N] (viii) approximately 10 cm³ 0.05 mol dm⁻³ silver nitrate solution labelled **silver nitrate**
- (ix) 6 test-tubes (approx. 125 mm × 15 mm)
- (x) approximately 20 cm³ distilled water
- (xi) stirring rod
- (xii) red litmus paper
- (xiii) blue litmus paper
- (xiv) Bunsen burner and means to light it
- (xv) beaker or other means to support test-tubes
- (xvi) test-tube holders for heating.

Note

Centres may provide fewer test-tubes, the minimum being 2 test-tubes (approx. 125 mm × 15 mm). If this is the case, candidates will have to rinse test-tubes with a supply of distilled water.

For Question 6

Each candidate will require:

- (i) steel spring approximately 55 mm long and a diameter of 15 mm (see www.philipharris.co.uk, catalogue number B8G87194)
- (ii) clamp, stand and boss (see note 1)
- (iii) 30 cm or 50 cm ruler, graduated in millimetres
- (iv) mass of 300 g (see note 2)
- (v) stone of mass between 150 g and 200 g (see note 3)
- (vi) 500 cm³ beaker containing approximately 300 cm³ of water.

Notes

- 1 The apparatus is to be set up for candidates as shown in Fig. 6.1. The spring is to be sufficiently high above the bench so that when the 300 g mass is suspended on the spring, the bottom of the mass is approximately 10 cm above the surface of the bench. Ensure that the spring is held tightly in the clamp.

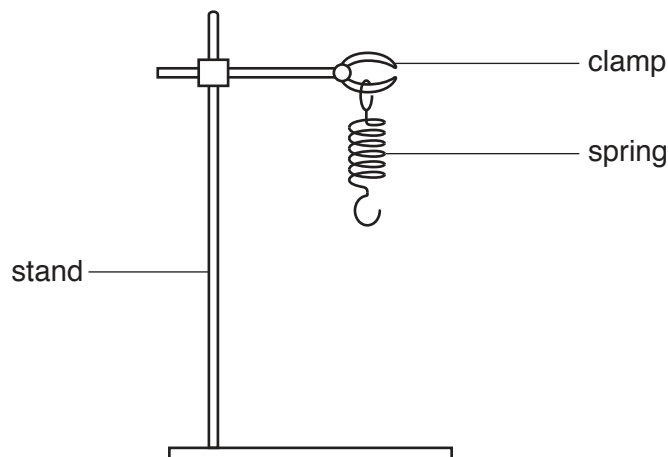

Fig. 6.1

- 2 A 100 g mass hanger with two 100 g slotted masses is ideal. If these are not available, a suitable light hook must be provided so that the masses can be attached to the spring.
- 3 There must be a means of allowing the stone to be suspended from the spring. A small length of thin copper wire wound around the stone, with the end of the wire bent to form a hook shape is sufficient.

Action at Changeover

- Ensure that the stone is removed from the spring and dried.
- Restore the apparatus to the form described in note 1.

BLANK PAGE

Permission to reproduce items where third-party owned material protected by copyright is included has been sought and cleared where possible. Every reasonable effort has been made by the publisher (UCLES) to trace copyright holders, but if any items requiring clearance have unwittingly been included, the publisher will be pleased to make amends at the earliest possible opportunity.

To avoid the issue of disclosure of answer-related information to candidates, all copyright acknowledgements are reproduced online in the Cambridge Assessment International Education Copyright Acknowledgements Booklet. This is produced for each series of examinations and is freely available to download at www.cambridgeinternational.org after the live examination series.

Cambridge Assessment International Education is part of the Cambridge Assessment Group. Cambridge Assessment is the brand name of the University of Cambridge Local Examinations Syndicate (UCLES), which itself is a department of the University of Cambridge.

Supervisor's report

Syllabus and component number

				/		
--	--	--	--	---	--	--

Centre number

--	--	--	--	--

Centre name

Time of the practical session

Laboratory name/number

Give details of any difficulties experienced by the centre or by candidates (include the relevant candidate names and candidate numbers).

You must include:

- any difficulties experienced by the centre in the preparation of materials
- any difficulties experienced by candidates, e.g. due to faulty materials or apparatus
- any specific assistance given to candidates.

Declaration

- 1 Each packet that I am returning to Cambridge International contains the following items:
 - the scripts of the candidates specified on the bar code label provided
 - the supervisor's results relevant to these candidates
 - the supervisor's reports relevant to these candidates
 - seating plans for each practical session, referring to each candidate by candidate number
 - the attendance register
- 2 Where the practical exam has taken place in more than one practical session, I have clearly labelled the supervisor's results, supervisor's reports and seating plans with the time and laboratory name/number for each practical session.
- 3 I have included details of difficulties relating to each practical session experienced by the centre or by candidates.
- 4 I have reported any other adverse circumstances affecting candidates, e.g. illness, bereavement or temporary injury, directly to Cambridge International on a *special consideration form*.

Signed (supervisor)

Name (in block capitals)